

## Seismic Design and Performance of Dual Moment and Eccentrically Braced Frame System Using PBPD Method

### Abstract

Most structural design codes use elastic analysis to calculate and distribute seismic base shear over the height. This may lead to unsuitable design and may cause undesirable damages to the structure. To solve this problem, in recent years the Performance-based Plastic Design (PBPD) method which considers the plastic behavior of the structure, has been proposed. In this study, the PBPD method is extended to the dual system of moment and eccentrically braced frames. As a code requirement, in dual systems the moment frame must be able to resist at least 25 percent of the base shear. In the proposed PBPD method, the shear resistance of each system is selected at the beginning of design process and this criterion can be contributed to the design process directly. In this regard, three 6, 12 and 20 story structures are designed based on PBPD and conventional method. To assess the behavior of each system, non-linear pushover and time history analysis are conducted. Results show that dual frames that are designed by PBPD method have less stiffness and strength than frames that are designed by ordinary method. However the yield mechanism is controllable and plastic deformation capacity of structures are better conducted to design in PBPD method. The results also show that the collapse probability of frames that are designed by PBPD method is acceptable.

### Keywords

PBPD (Performance-based Plastic Design), Dual systems, Plastic hinge, Story drift, Plastic rotation of the links

A. Karamodin <sup>a</sup>

A. Zanganeh <sup>b</sup>

<sup>a</sup> Assistance professor. engineering faculty. Ferdowsi University of Mashhad., PO Box 41778-1111, Vakil abad. Mashhad., Iran.a-karam@um.ac.ir

<sup>b</sup> PHD student of structural engineering. Engineering faculty. Ferdowsi University of Mashhad., PO Box 41778-1111, Vakil abad., Mashhad., Iran.a.zanganeh118@gmail.com

<http://dx.doi.org/10.1590/1679-78253425>

Received 09.10.2016

In revised form 22.12.2016

Accepted 31.12.2016

Available online 09.01.2017

## 1 INTRODUCTION

Most structural design codes use elastic behavior of structures to calculate seismic base shear based on many parameters such as structural system, geometry and site location. The base shear is then distributed over the high of the structure. The distribution of base shear over the high is also based on elastic behavior of the structure. The nonlinear behavior of structures under severe earthquakes

is conducted to the calculation of base shear indirectly by many parameters such as Response modification factor ( $R$ ) Over-strength coefficient ( $\Omega$ ) and displacement amplification factor ( $C_d$ ).

Usually nonlinear behavior of structures appears on specific parts of structural members such as end of beams and columns in moment frames and diagonal members in concentrically braced frames. These elements are called fuse. Fuse elements are designed based on the seismic loads. Fuse elements must also have enough ductility to dissipate seismic energy. Design of other members is performed based on the maximum force produced by the fuse elements. This method is called the Capacity Design Method. In this method, which is not in compliance with the real behavior of the structure, undesired and unpredictable damages may be imposed to the structure.

To solve this problem, the performance-based plastic design (PBPD) method has been introduced [Leelataviwat S et al. (1999), Leelataviwat S et al. (2007), Lee SS and Goel SC (2001), Dasgupta P et al. (2004), Chao SH and Goel SC (2006a,b), Chao SH et al. (2007), (Chao SH and Goel SC (2008) ]. The PBPD method is based on the energy method (Housner GW, 1956). In this method, target drift and yield mechanism of the structure are used as performance parameters. As an example, the ideal yield mechanism in moment frames, MRF, is the flexural yielding at the two ends of the beams and end of columns on the base. In eccentrically braced frames the ideal yield mechanism is shear or flexural yielding of links, and ultimately, flexural yielding at the column base at the first floor. The concept of PBPD was first recommended, for, eccentrically braced frames, EBF, based on the moment balance method (Roeder, C. W. and Popov, E. P., 1977).

PBPD has been also used to design moment frames (MRF) with lateral force distribution based on UBC97 code (Leelataviwat S et al. 1998). Considering the fact that UBC97 lateral force distribution does not take into account the effect of the higher modes and nonlinear behavior of the structure, this method has been used again, on moment frames, with a kind of lateral force distribution that considers nonlinear behavior (Lee SS and Goel SC, 2001). The results of this study showed that yielding occurred more uniformly over the structure. The, force distribution used in this research which has been obtained based on the nonlinear time history analysis, was considered to be exponential. This method has also been used on the eccentrically braced frames with asymmetric horizontal links (H-EBF) (Chao SH, Goel SC, 2005). It has also been used on moment special truss and concentrically braced frames (Chao SH, Goel SC, 2006a,b). Bayat et. al. (2010) summarizes this method to different lateral resisting earthquake systems. Sahoo, D.R. and Chao, S. H., (2010) use this method for buckling-restrained braced frames. PBPD method are used on RC special moment frame structures by Liao et. al. (2010) and Liao, W.C. and Goel S. C., (2012). Design of EBF with vertical links (V-EBF) has also been studied through this method (Shayanfar. M.A, 2012). Also PBPD method has been used on steel plate shear wall, non-ductile reinforced concrete frames by buckling-restrained braces, steel moment resistant frame and steel concentric braced frames (Swapnil B et al., 2013, Khampanit.A, et al., 2014, Banihashemi, M.R, et al., 2015a,b, Er-Gang Xiong, et al., 2015).

Recently, the authors have used this method for coupled concrete shear walls with steel link (A. Karamodin and A. Zanganeh, 2015). All studies have verified that, in this method, the yield mechanism is controllable, and the plastic deformation capacity of elements is better conducted to design.

## 2 PERFORMANCE-BASED PLASTIC DESIGN (PBPD) METHOD

PBPD method uses pre-selected target drift and yield mechanism as performance objectives. The degree and distribution of structural damage are directly related to these design parameters, respectively. The design base shear for a specified hazard is calculated by equating the work needed to push the structure monotonically up to the target drift to the energy required by an equivalent EP-SDOF to achieve the same state (Chao SH and Goel SC, 2005). Accordingly, the energy balance relation can be written as (1).

$$(E_e + E_p) = \gamma \left( \frac{1}{2} M S_v^2 \right) = \frac{1}{2} \gamma M \left( \frac{T}{2\pi} C_e g \right)^2 \tag{1}$$

In this relation,  $E_e, E_p$  are, respectively, the plastic and elastic energy portions required to push the structure up to the target drift,  $S_v$  is the design pseudo-spectral velocity,  $M$  is the total mass of the structure,  $\gamma$  is the energy modification factor,  $C_e$  is the normalized design pseudo-acceleration,  $T$  is the period of the structure and  $g$  is the gravity acceleration. According to Fig. 1, the energy modification factor can be obtained as follows:

$$\gamma \left( \frac{1}{2} C_e W \Delta_e \right) = \frac{1}{2} C_Y W (2\Delta_{\max} - \Delta_y) \tag{2}$$

$$\gamma = \frac{2\mu_s - 1}{R^2 \mu} \tag{3}$$

In the above equation, parameters  $C_e, \Delta_e, C_Y, \Delta_{\max}$  and  $\Delta_y$  are shown in fig. 1,  $C_s$  is the seismic response coefficient that is calculated based on specific design code;  $\Omega$  is Over-strength coefficient,  $C_Y$  is seismic coefficient in ultimate yield force level,  $\Delta_s, \Delta_y, \Delta_e$  are respectively drift in  $C_s, C_Y$  and  $C_e$  level,  $R$  is Response modification factor,  $R_\mu$  is the ductility reduction factor,  $\mu_s$  is the structural ductility factor, which can be written as Eqs. (4) and (5).

$$R_\mu = \frac{C_e}{C_y} \tag{4}$$

$$\mu_s = \frac{\theta}{\theta_y} \tag{5}$$

Obtaining of  $R_\mu$  are suggested by Chao SH and Goel SC, (2005).

Plastic energy is resulted from the external work done by lateral loads, in the form of Eq. (6).

$$E_p = \sum_{i=1}^n F_i h_i \theta_p \tag{6}$$

In above equation  $F_i$  is the lateral force at  $i^{\text{th}}$  story and  $h_i$  is the  $i^{\text{th}}$  story height from base.

Elastic energy is set as Eq. (7), supposing that the structure has been decreased to a single degree of freedom system (SDOF)

$$E_e = \frac{1}{2} M \left( \frac{T}{2\pi} \frac{V}{W} g \right)^2 \tag{7}$$

By substituting Eqs. (6)-(7) in Eq. (1), base shear will be written as Eq. (8).

$$V = \frac{-\delta + \sqrt{\delta^2 + 4\gamma C_e^2}}{2} W \tag{8}$$

In which  $\delta$  is a dimensionless parameter which depends on the structural stiffness, modal characteristics and target drift, which can be calculated from Eq. (9).

$$\delta = \left( \sum_{i=1}^n (\beta_i - \beta_{i+1}) \right) \left( \frac{W_n h_n}{\sum_{j=1}^n W_j h_j} \right)^{\kappa T - 0.2} \cdot \left( \frac{\theta_p}{T^2 g} \right) \tag{9}$$

In this equation,  $\beta_i$  is the shear distribution factor, which is calculated from Eq. (10).

$$\frac{V_i}{V_n} = \beta_i = \left( \frac{\sum_{j=i}^n W_j h_j}{W_n h_n} \right)^{\kappa T - 0.2} \tag{10}$$

$\theta_u$  and  $\theta_y$  are, target and yield drift, respectively, and  $\theta_p$  is plastic drift which is calculated from Eq. (11).

$$\theta_p = \theta_u - \theta_y \tag{11}$$

$W_i$  is weight of  $i^{\text{th}}$  story,  $W$  is the total weight of the structure and  $\kappa$  is the exponential distribution factor which is selected based on the structural lateral load resisting system. For example in moment and eccentrically braced frames  $\kappa$  have been suggested as 0.5 and 0.75 respectively [(Lee SS and Goel SC, 2001), (Chao SH, Goel SC, 2005)]. In this method, the lateral force in the top story is calculated through Eq. (12), and shear force distribution in the height is assumed as Eq. (13).

$$F_n = V \left( \frac{W_n h_n}{\sum_{j=1}^n W_j h_j} \right)^{\kappa T - 0.2} \tag{12}$$

$$F_i = (\beta_i - \beta_{i+1}) V_n \text{ if } i=n \text{ then } \beta_{i+1} = 0 \tag{13}$$

In above equation  $V$  is the base shear ,  $V_n$  is shear at  $n^{th}$  story and  $F_i$  is lateral force at  $i$ ,th story.

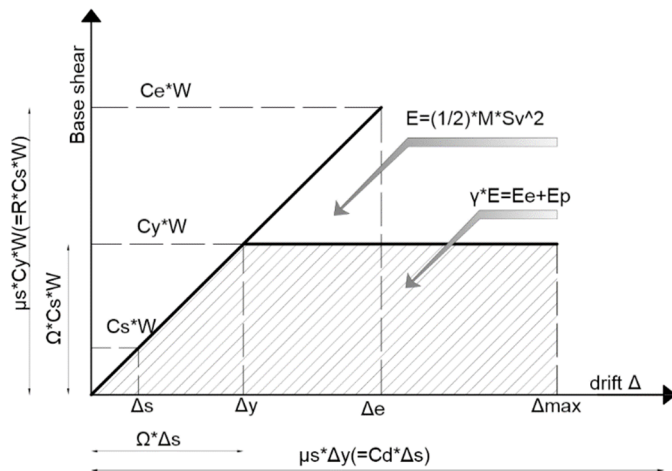

Figure 1: Ideal behavior of structure and concept of balance energy (Chao and Goel, 2005).

### 3 DUAL SYSTEMS

Dual system is a system in which the resistance against lateral forces is formed through a series of shear walls or braced frames, with a series of moment frames. The shear portion of each series is determined based on their lateral stiffness and their interactions in all stories. Ductility and stiffness are respectively the characteristics of moment frames and braced frames. However, great relative displacements in the upper stories of the moment frames and great story shear in the lower stories of the braced frames are considered to be their problems. Using the moment and braced dual system increases the benefits of each, and decreases their inconvenience. According to the design codes, a system is considered a dual system, if the moment frame bears at least a specified percent of the total shear. In dual frames connection between beam and column, column and foundation and between brace and beam is rigid. And connection between brace and column is moment release.

In conventional method, to design a dual system, the story shears is divided between each subsystem, according to their stiffness, and then each subsystem is designed based on its shear portion. According to AISC (2010) the moment frame alone must be checked to resist at least 25 percent of the base shear. In the PBPD method presented in this paper, the shear resistant of each subsystem from total shear, is selected and entered to the design process directly. So there is no need to control the minimum resistance of the moment frame as required by the codes.

Generally, the conventional design method does not guarantee the formation of a desired yield mechanism in the structure, whereas the PBPD method has more ability to push the structure towards a desired yield mechanism.

The desired yield mechanism in the dual system of moment and eccentrically braced frame is the formation of plastic hinges in the link beams and the moment frame beams, and ultimately the formation of plastic hinges at the column bases.

Considering the desirable performance of the PBPD method, in moment, concentric and eccentric braced frames, in this paper, this method is developed to the dual system of moment and eccentric braced frame. To this end, three (6 story, 12 story and 20 story) dual system structures are selected. These frames are designed based on the conventional and PBPD method, using the AISC (2010) and IBC (2009) codes. To study the nonlinear behavior and hinge formation mechanism, pushover analysis is used.

#### 4 DEVELOPING THE PBPD METHOD FOR DUAL MOMENT AND ECCENTRICALLY BRACED FRAMES

Using the performance-based plastic design method, the desired yield mechanism and performance level of the structure must be selected. Three Performance design levels are presented in FEMA 356 code, which are immediate occupancy performance level (IO) (the structure is controlled against an earthquake of 50% occurrence probability in 50 years), life safety performance level (LS) (the structure is controlled against an earthquake of 10% occurrence probability in 50 years) and collapse prevention level (CP) (the structure is controlled against an earthquake of 2% occurrence probability in 50 years). For each performance level, FEMA 356 has suggested a target ultimate story drift ( $\theta_u$ ).

In this study desired yield mechanism in the moment and eccentric braced frame dual system is formation of hinges in the link elements, the formation of moment hinges at the end of the beams and ultimately the formation of hinges at the column bases. Upon selecting the yield mechanism and target drift, base shear will be obtained from Eq. (8).

In the next step, the base shear must be divided between the moment and the eccentric braced frames. Afterwards the base shear of moment and eccentric braced frame subsystems must be divided over the high of each one according to Eq. (13). Knowing the yield mechanism of each subsystem and writing the equilibrium equation between the external work done by external forces and internal work done by internal forces at hinge locations, the internal forces can be calculated.

Fig. 2 shows the yield mechanism with the external and internal forces at hinge locations of the moment frame. Writing the energy equilibrium equation leads to Eq. (14) for calculating the beam end moments:

$$M_{pbr} = \frac{\sum F_i' h_i - (n+1)M_{pc1}}{2n \sum \beta_i} \quad (14)$$

In this equation  $F_i'$  is external forces of moment frame at story levels ( $F_i'$  is obtain from Eq. (13) by assuming  $\kappa = 0.5$ ) and  $M_{pc1}$  is column base moments.  $n$  is the number of frame span in the specific direction and  $h_i$  is the height of  $i$ 'th story from base. Value of  $M_{pc1}$  can be determined by using the condition that no soft story mechanism would occur in the first story, when a factor of 1.1 times the design lateral forces are applied on the frame (Leelataviwat S et al. 1999). Assuming that plastic hinges form at the base and top of the first story columns, the corresponding work equation for a small mechanism deformation gives:

$$M_{pc1} = \frac{1.1\phi V'_1 h_1}{2} \tag{15}$$

$V'_1$  is the column base shear calculating by dividing the frame base shear between columns and  $h_1$  is the high of the first story.

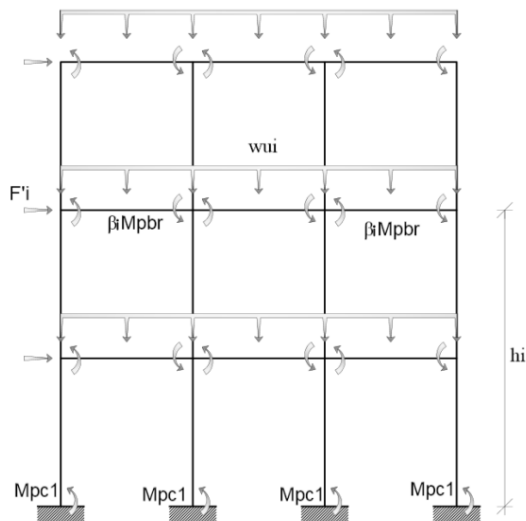

Figure 2: Maximum expected moment in moment frame.

For the Eccentrically braced frame, yield mechanism is selected as shear or flexural hinge in the links, as seen in Fig. 3 Applying lateral force to the bracing system, equalizing the work of external forces to that of internal ones, the maximum expected link shears will be obtained from the following Eq.

$$V_{pr} = \frac{\sum F_i'' h_i}{L \sum \beta_i} \tag{16}$$

In the above equation  $F_i''$  is the external force of braced frame at story levels that is obtained from Eq. (13) by assuming  $\kappa = 0.75$ .

Upon acquiring design shear at the links, the section design of links is performed based on AISC (2010) code provisions.

Design of column members in moment frames, must be based on the combination of factored gravity loads and maximum expected strength of beams. For this purpose a “column tree” free diagram as shown in Fig. 4 must be considered. At this stage, the required lateral forces acting on this free body must be calculated. The distribution of these forces may be assumed to maintain as given by Eq. (12), and their magnitude can be easily obtained by using equilibrium of the entire free body as follows:

$$F_{R1} = \frac{\sum [M_{bil})_R + M_{bil})_L] + M_{pc1}}{\sum \alpha_i h_i} \quad (17)$$

In this equation  $M_{bil})_R$  and  $M_{bil})_L$  respectively are the maximum expected moment beam hinges at the right and left side of column.

In above equation, coefficient  $\alpha_i$  is obtained as follows:

$$\alpha_i = \frac{F_i}{\sum_{i=1}^n F_i} = \frac{(\beta_i - \beta_{i+1})}{\sum_{i=1}^n (\beta_i - \beta_{i+1})} \quad (18)$$

Then the column end moments and shear force in each story are calculated by applying the expected beam end moments and lateral forces applied at each level.

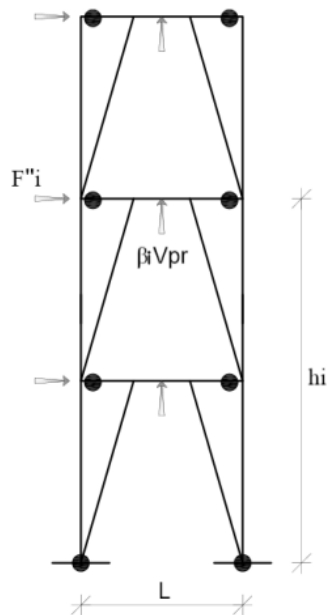

**Figure 3:** Maximum Expected shear in braced frame.

The design of elements outside the shear links in braced frame, including beams, braces, and columns, is also performed based on the capacity design approach. That is, elements outside the shear links should have a design strength to resist the maximum expected shear and moments developed in the links. Once the maximum expected link shear and moments are determined, the frame can be cut into several free body diagrams Fig. 5 The lateral forces on these diagrams must be updated. They should be updated based on the expected strength of shear links because they have significant influence on the internal forces of members outside the shear links. The required balancing lateral forces are assumed to maintain the distribution as used earlier and can be easily calculated by using moment equilibrium of the free body as Eq. (19):



$$F_{R2} = \frac{M_{pc1} + \sum M_{bi2} + \frac{L-e}{2} \sum V_{ui2} - \frac{(L-e)^2}{8} \sum w_{ui} - 2 \sum M_{bi1}}{\sum \alpha_i h_i} \tag{19}$$

In the above relation:

$$V_{ui2} = 1.1 R_y V_u \tag{20}$$

$$M_{bi2} = V_{ui2} * e / 2 \tag{21}$$

$$V_u = \min(V_p, \frac{2M_p}{e}) \tag{22}$$

$$V_p = 0.6 F_y (d_b - 2t_f) t_w \tag{23}$$

$$M_p = Z F_y \tag{24}$$

L and e are respectively the length of span and link element and  $w_{ui}$  is the factored dead and live load combination at  $i^{th}$  story.  $R_y$  is the ratio of maximum expected yield stress to minimum yield stress in material.

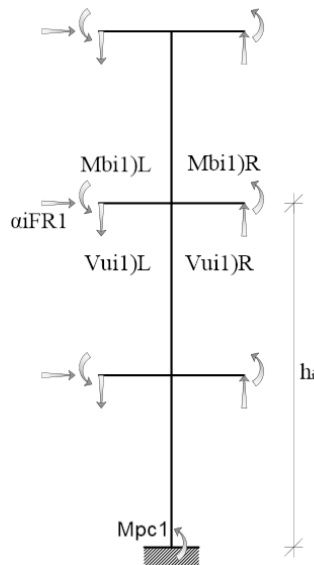

**Figure 4:** Lateral force for designing of out of link member in moment frame (note: shear and moment forcé are in the intersection point of beam and column).

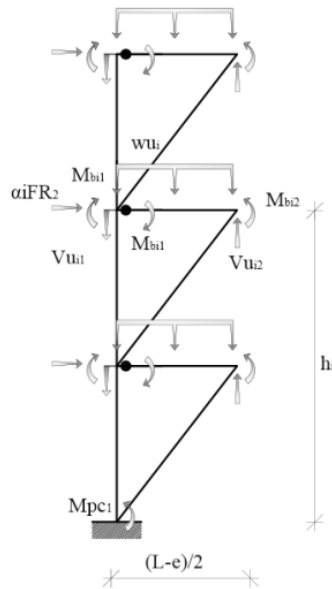

Figure 5: Lateral force for designing of out of link member in braced frame.

### 5 PROBABILITY COLLAPSE EVALUATION

One of the effective ways for assessing the vulnerability of structures is Seismic risk assessments. Fragility assessments have an important role in a seismic risk assessment to evaluate the correctness of design method. For obtaining the fragility curve that shows collapse probability in maximum acceleration ground motion, earthquake records are selected and for each record, maximum inter-story drift is obtained. And by using exponential regression ( $y = as^b$ ) curve of drift according peak ground motion acceleration (PGA) is obtained. And fragility curve derive by using below fragility relation that is developed by Wen et.al (2004).

$$P(LS|PGA) = 1 - \phi\left(\frac{\lambda_{cl} - \lambda_{D|PGA}}{\sqrt{\beta_{D|PGA}^2 + \beta_{CL}^2 + \beta_M^2}}\right) \tag{25}$$

In above equation,  $\phi$  is normal standard distribution, and  $\lambda_{cl}$  is ln (average capacity drift for specified limit),  $\lambda_{D|PGA}$  is ln(average demand drift for PGA),  $\beta_{D|PGA}$  is demand uncertainty,  $\beta_{CL}$  is capacity uncertainty and  $\beta_M$  is modeling uncertainty. Demand uncertainty obtains from below equation:

$$\beta_{D|PGA} = \sqrt{\ln(1 + s^2)} \tag{26}$$

$s^2$  is standard variance in exponential regression.  $\beta_{CL}$  and  $\beta_M$  are suggested to be 0.3 (Wen et al. (2004), Bai (2004)).  $\lambda_{cl}$  For each limit state obtain from FEMA 356. By substituting of required parameter in Eq.25, fragility curve is drawn.

For collapse evaluation selected records must be normalized. scale factor (SF) obtain:

$$SF = \frac{ACMR_{10\%}}{C_{3D}SSF} \left( \frac{S_{MT}}{S_{NRT}} \right) \quad (27)$$

$ACMR_{10\%}$  is collapse margin, that obtain from FEMA P-695. For 2D structure  $C_{3D}=1$ ,  $S_{MT}$  is acceleration response spectrum that obtain from ASCE/SEI 7-05 and  $S_{NRT}$  is normalized average earthquake that obtain from FEMA P-695.

Each record is applied on structures and results are collapse or non-collapse. Collapse limit states are based on table C1-3 in FEMA 356 (2000). According to FEMA P695 If less than one half of the records causes collapse, the structure meets the collapse performance objective and collapse probability of the structure under MCE (Maximum Considered Earthquake) ground motions is accepted.

## 6 CASE STUDY

Designed structures are in Design category D, site class C and occupancy category II. The design parameters and base shear of the structures for conventional method are calculated based on IBC 2009. These parameters for 12 story structure are included in table 1.

For PBPD method desired performance level of structures is to be Life Safety (LS). The target drift ( $\theta_u$ ) for this performance level is suggested to be 0.02. Due to the fact that suggested yield drifts for moment and eccentrically braced frames are 0.01 (Lee SS and Goel SC, 2001) and 0.005 (SH Chao and SC Goel, 2005) respectively, the yield drift in dual frame is assumed to be determined as a linear combination of yield drifts in the moment and eccentrically braced frames based on the percentage of their base shear. In this study the moment frames will be designed for 25% of base shear. So the yield displacement for dual frame is calculated as 0.00625. The selected yield mechanism for these structures consists of formation of shear or moment hinges in the horizontal link elements of the braced frame, formation of flexural hinges at the end of the beams and finally, formation of hinges at the column bases. The base shears of structures are calculated from Eq. 8. The base shear and parameters of PBPD method for 12 story structure are shown in table 1.

Upon determining the base shear of the moment and eccentrically braced frames, they are distributed over the high of each frame using Eq. (13). Afterwards the beam end moments can be calculated from Eq. (14), and then suitable frame sections selected. Similarly link beams in eccentrically braced frames can be designed for the maximum shear calculated from Eq. (16). The designed sections of 12 story moment frame beams and eccentrically braced links are shown in table 2. It can be seen that the link and the flexural beam sections in the PBPD method are smaller than those in the conventional method.

After designing of beams and links in different stories of the frames that are designed by PBPD method, the maximum expected moment and shear and lateral forces equilibrating with these forces

are calculated from Eq. (17) - (18) respectively for the moment and braced frames. Table 3 shows the calculated forces for the 12 story structure. The columns of moment and braced frames will be designed as indicated in section 4. The columns of the ordinary frame will be designed using the conventional methods. Table 4 indicates the characteristics of the column sections of the moment and braced frames of the 12 story structure, designed through the PBPD and conventional methods.

Ordinary method Parameters	12-story	PBPD method Parameters	12-story
Ss	1.31	Cs=v/w	0.05
S1	0.45	Ce	0.403
Fa	1	Yield Drift $\vartheta_y$ (rad)	0.00625
Fv	1.35	Target Drift $\vartheta_u$ (rad)	0.02
Sds	0.873	$\mu_s$	3.2
Sd1	0.405	R $\mu$	3.2
Building Height (m)	36	$\gamma$	0.527
Ta (sec)	0.717	$\delta$	2.918
Cu	1.4	v/w	0.029
T (sec)	1	Design Base Shear V (kg-f)	30945
Sa	0.403		
I	1		
R	8		
Total Building Weight W (N)	1063132		
Design Base Shear V (kg-f)	53602		

**Table 1:** Design parameter in PBPD method in 12 story frame.

story	Link section		Moment beam section	
	PBPD	conventional	PBPD	conventional
12	IPE140	IPE180	IPE140	IPE180
11	IPE140	IPE200	IPE160	IPE240
10	IPE140	IPE200	IPE160	IPE240
9	IPE140	IPE200	IPE180	IPE270
8	IPE180	IPE270	IPE180	IPE270
7	IPE180	IPE270	IPE180	IPE270
6	IPE180	IPE300	IPE200	IPE270
5	IPE180	IPE330	IPE200	IPE240
4	IPE200	IPE330	IPE200	IPE240
3	IPE200	IPE360	IPE200	IPE220
2	IPE200	IPE360	IPE200	IPE220
1	IPE200	IPE330	IPE200	IPE220

IPE is European standard universal I beams (I section) with parallel flanges.

**Table 2:** Required link and flexural beam cross section in different storeis of 12 story frames.

Story	$V_{u1}(kgf)$	Moment Frame		$V_{u2}(kgf)$	Braced frame	
		$M_{b1}(kgf.cm)$	$\alpha_i F_{R1}(kgf)$		$M_{b2}(kgf.cm)$	$\alpha_i F_{R2}(kgf)$
12						
11	1505.9	37646.4	178.94	10723.15	268078.8	2632.48
10	1505.9	37646.4	125.05	10723.15	268078.8	2110.45
9	2015.9	50397.6	96.47	10723.15	268078.8	1764.45
8	2015.9	50397.6	77.16	17378.06	434451.6	1490.94
7	2015.9	50397.6	62.55	17378.06	434451.6	1258.26
6	2683.8	67095.6	50.65	17378.06	434451.6	1050.26
5	2683.8	67095.6	40.4	17378.06	434451.6	857.47
4	2683.8	67095.6	31.28	20401.92	510048	675.53
3	2683.8	67095.6	22.92	20401.92	510048	501.33
2	2683.8	67095.6	15.04	20401.92	510048	331.99
1	2683.8	67095.6	7.46	20401.92	510048	165.46
$M_{PC}(kgf.cm)$			90184.25			

**Table 3:** Required parameter for designing of out of link and flexural beam members in PBPD method, in different stories of 12 story frame (kg, cm).

Story	PBPD method		Ordinary method	
	Braced frame	moment frame	Braced frame	moment frame
12	Box20x20x2	Box20x20x1	Box10x10x1	Box10x10x1
11	Box25x25x2	Box20x20x2	Box10x10x1	Box20x20x1
10	Box25x25x2	Box25x25x2	Box15x15x1	Box20x20x1
9	Box25x25x2	Box25x25x2	Box15x15x1	Box20x20x1
8	Box30x30x2	Box25x25x2	Box15x15x1	Box20x20x1
7	Box30x30x2	Box25x25x2	Box15x15x1	Box20x20x1
6	Box30x30x2	Box25x25x2	Box20x20x1	Box20x20x1
5	Box30x30x2	Box25x25x2	Box20x20x1	Box20x20x1
4	Box30x30x2	Box25x25x2	Box20x20x2	Box20x20x1
3	Box30x30x2	Box25x25x2	Box20x20x2	Box20x20x1
2	Box30x30x2	Box25x25x2	Box25x25x2	Box20x20x1
1	Box30x30x2	Box25x25x2	Box30x30x2	Box20x20x1

**Table 4:** Column section in different stories of 12 story frames.

In BOXa\*b\*c, a is width of section, b is depth of section and c is thickness of section. dimensions are in mm.

### 7 PERFORMANCE EVALUATION

Two methods are used to evaluate the performance of the structures designed based on ordinary and PBPD method. Firstly a static nonlinear analysis is used to evaluate yield mechanism and hinge formation, push over curve, demand ductility, inter-story drift and link rotations. A series of time history analysis are also used to construct the fragility curves of structures and determine collapse probabilities based on FEMA695.

## 7.1 Static Nonlinear Analysis

To evaluate the performance behavior of structures designed based on the two methods, a static nonlinear analysis is conducted. For static nonlinear analysis the equivalent static load pattern is selected and the structures are pushed over a specified drift of roof.

The target drift of each structure under the design earthquake spectrum is calculated and the performance of structures designed based on PBPD method is compared with structures designed based on the conventional method. Several factors are compared. The first factor is the hinge formation and yield mechanism of the structures. Fig. 6 shows the number and order of hinge formation at the same roof drift of the structures. In general it is seen that the number of hinges in the structures designed by PBPD method are more than the hinges in the structure designed by conventional method. For example, the number of hinges in the 20 story structures is 41 and 31 for structures that are designed by PBPD and conventional method respectively. It is also seen that in the 20 story structure that is designed by conventional method one column is yielded, however no column is yielded in the Structures that are designed by PBPD method. It can be concluded that more energy is dissipated in Structures that are designed by PBPD method and expected yield mechanism is nearly reached.

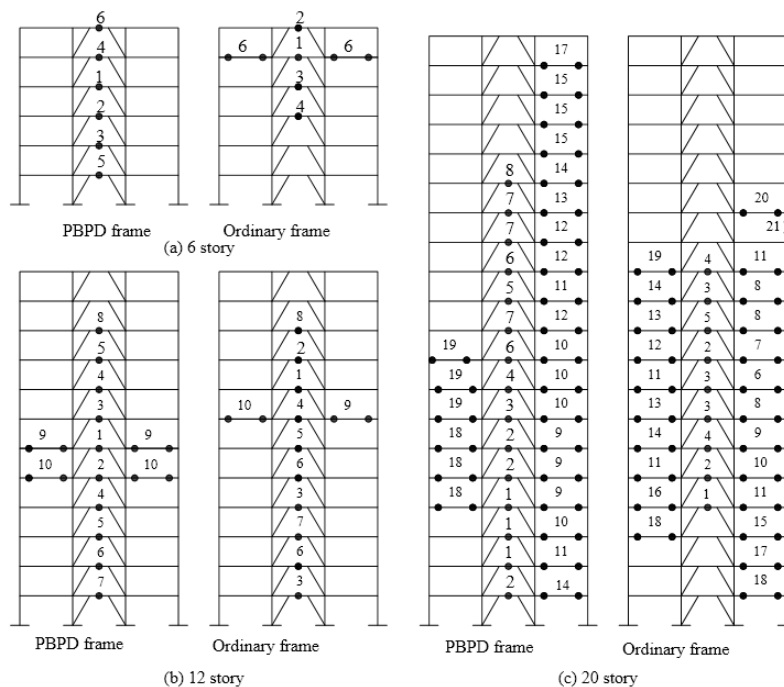
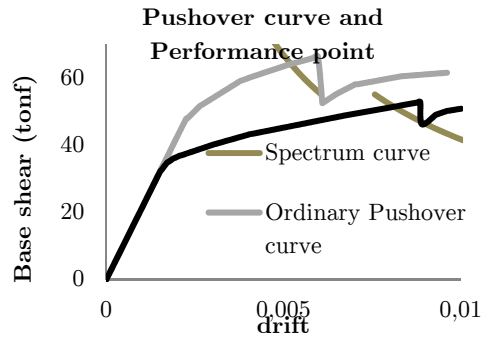

**Figure 6:** Comparison of hinge formation order.

The pushover curves of the structures are compared in Fig. 7, it can be seen from the figure that the stiffness and strength of Structures that are designed by PBPD method are less than structures that are designed by conventional method. For example the maximum strength of 12 story structures that are designed by PBPD and conventional method are 38 tonf and 100 tonf respec-

tively. It is also seen from the figure that in structures that are designed by conventional method the strength drop is accrued in less drift than Structures that are designed by PBPD method. This drop is due to strength drop in some member hinges. It can be concluded that however the structures that are designed by conventional method have more strength and less hinges but the plastic deformation are concentrated in some members. But in PBPD method structures the plastic deformation are distributed over more members.

As it is shown in Figure: 7 performance points obtains from intersection between spectrum curve and pushover curve according to FEMA440 (2005).



(a) 6 story frames

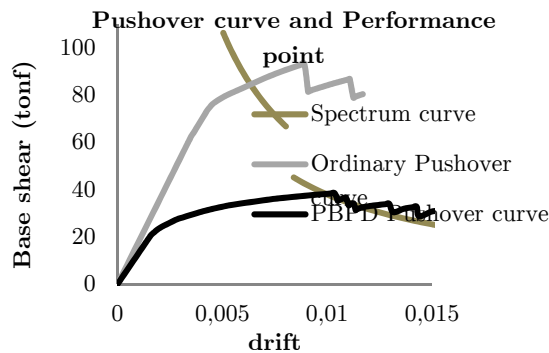

(b) 12 story frames

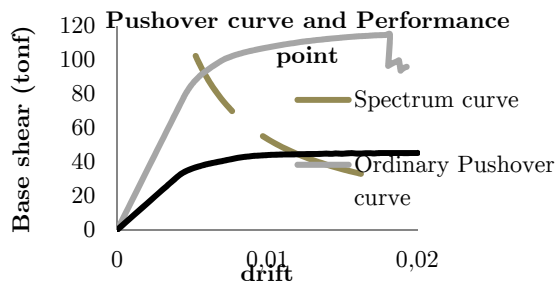

(c) 20 story frames

**Figure 7:** Pushover curve in two frames.

The ductility demand of structures at target drift is shown in Table 5. It obtains from dividing the target drift over the yield drift. It is seen that the ductility demand of Structures that are designed by PBPD method are more than the structures that are designed by conventional method. So it can be concluded that PBPD method can better include ductility of the structures in design process.

Frame	$\mu$ (ductility demand )
6- story PBPD method	4.4
6- story ordinary method	2.6
12- story PBPD method	3.3
12- story ordinary method	1.9
20- story PBPD method	3
20- story ordinary method	1.6

**Table 5:** Structural ductility demand of different frames.

The story drift and base shear at performance point are 0.01 and 38 ton for 12 story frame that is designed by PBPD method and 0.0075 and 90 ton for 12 story frame that are designed by ordinary method. Figure.8 shows the link rotation at the performance point for both structures that are designed by PBPD and ordinary method. It is seen from the figure that the maximum link rotation of the Frame that is designed by PBPD method at the performance point is larger than the frame that are designed by ordinary method. However it is less than maximum allowable (according to FEMA 356, CP limit state is 0.14 rad). For example, maximum amount of link rotation in 20 stories Frame that is designed by PBPD method is 0.05 rad and in 20 story frame that are designed by ordinary methods is 0.03 rad. It is also seen that, in 6 story frame that are designed by ordinary method link rotation suddenly increase at 5th story which is more than the CP limit this is due to poor design method that concentrats all plastic deformation in few members. In general it can be concluded that in PBPD method the plastic deformations are distributed over the height but in frames that are designed by ordinary method they are concentrated at some elements which may lead to unexpected damages.in the other words the rate of variation in distribution of plastic deformation in ordinary method is not as uniform as PBPD method.

The comparison of the inter-story drift at the performance point, for the structures designed based on the two different methods, are shown in Figure. 9. It is seen from the figure that in the Structures that are designed by PBPD method, the maximum inter-story drift is larger than frames that are designed by ordinary method. However in 6 stories frame that are designed by ordinary method inter story drift suddenly increases at 5th story because of design method. As an example, in figure 9-b for 12 story frame, inter story drift in critical story of Frame that is designed by PBPD method is 0.02 rad and in critical story of frame that are designed by ordinary method is 0.012 rad.

As a general performance it is concluded that the Structures that are designed by PBPD method have less strength than frame that are designed by ordinary method and plastic deformations are more in Frames that are designed by PBPD method. It means that in PBPD method ductility of structures is better conducted to the design of structures.



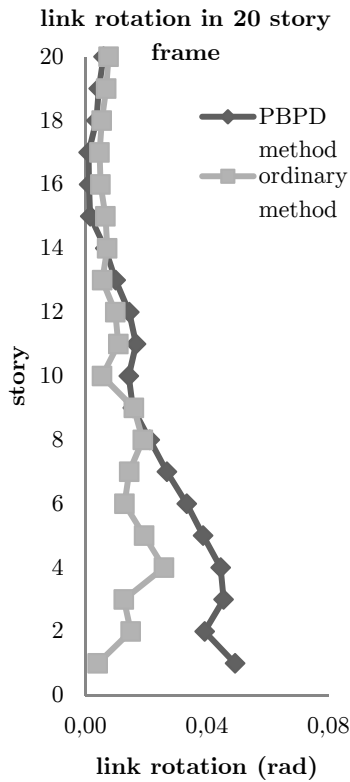
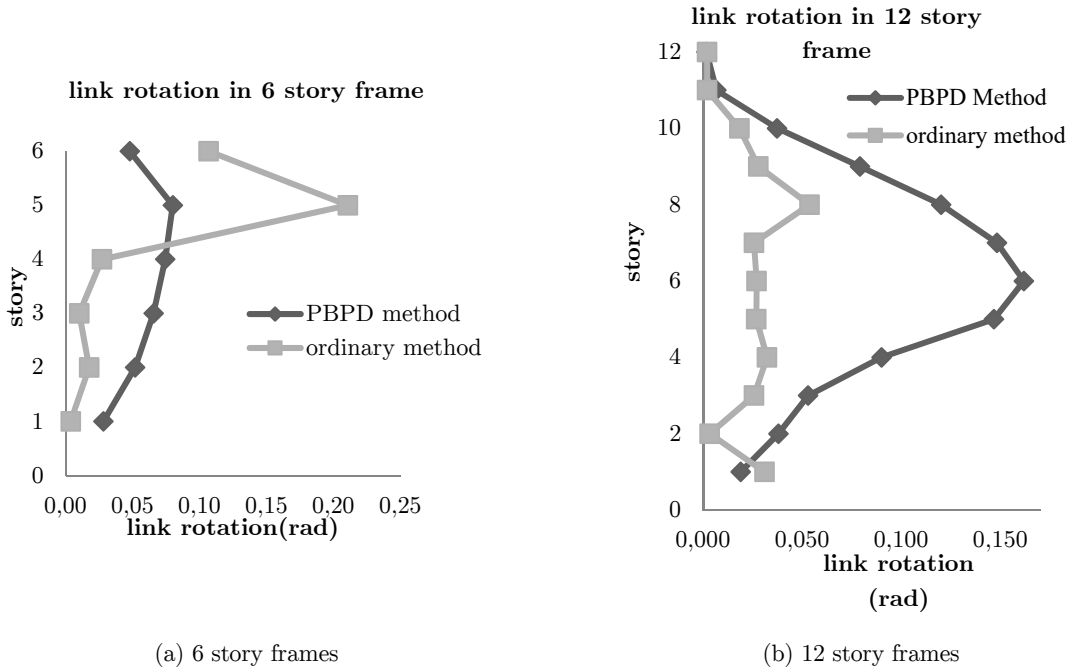

Figure 8: Link plastic rotation of two frames in performance point.

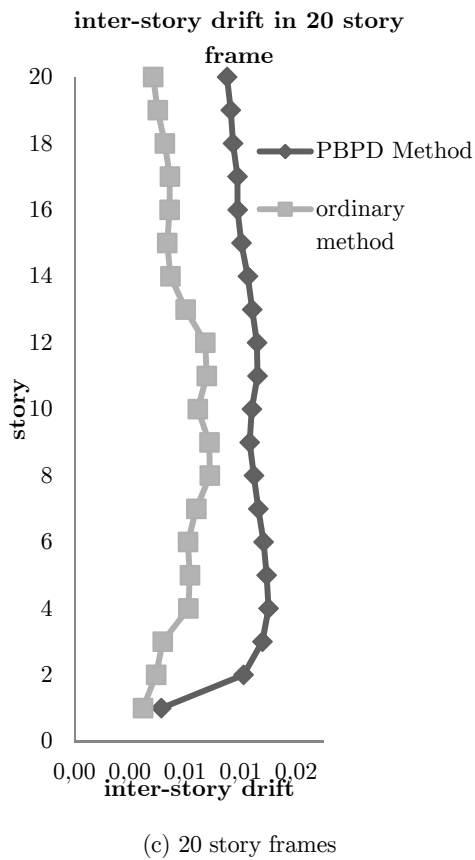
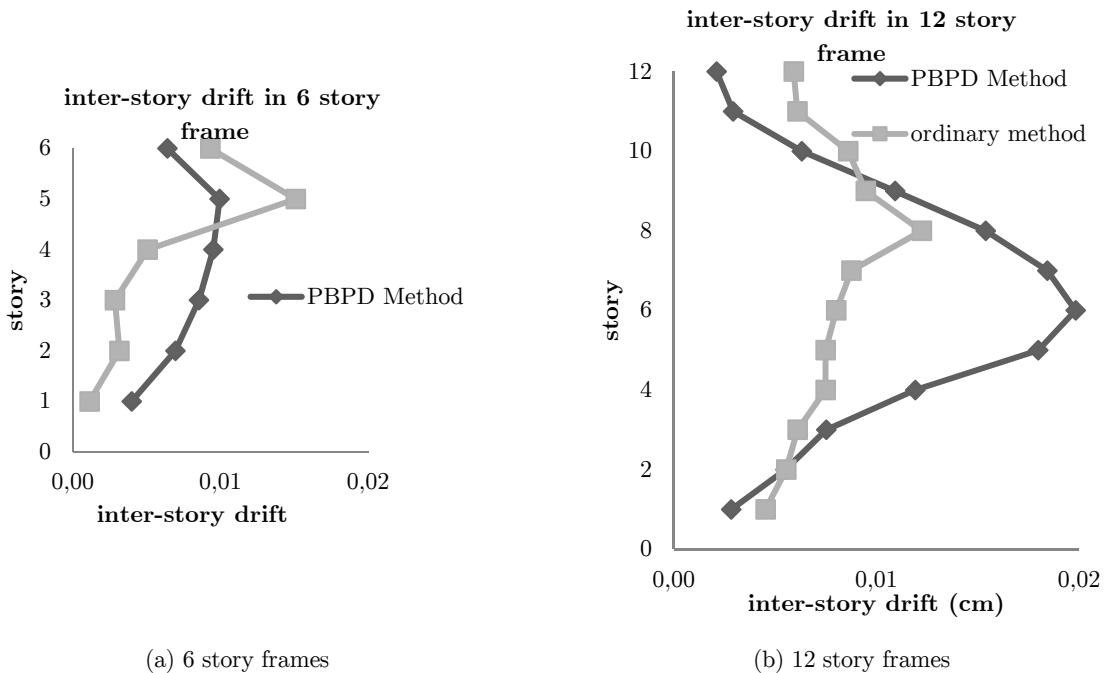

Figure 9: Inter- story drift in performance point.

## 7.2 Probabilistic Collapse Evaluation

In this section, according to FEMA P695 (FEMA P695, 2009) collapse probability of the Frames that are designed by PBPD and ordinary method have been evaluated. For this purpose, the fragility curve of each frame is obtained. For obtaining the Fragility curve and collapse evaluation, in this study, 22 records of Los Angeles earthquakes are selected (SAC steel ground motion). Characters of selected ground motion are in Table.6. Fragility curves for the CP limit state are obtained based on Eq.25. Table.7 calculates requirement parameter for obtaining fragility curve in 12 story frames that are designed by PBPD and ordinary method. Figure.10 compares the fragility curves of 6, 12 and 20 stories frames that are designed by PBPD and ordinary method. Figure shows that for a specific PGA, Collapse probability in Frames that are designed by PBPD method is lower than frames that are designed by ordinary method. For collapse evaluation, selected records are normalized according to FEMA P695 and then applied to each frame. Results are classified as collapsed and non-collapsed frames (FEMA P695, 2009). Collapse limit states are based on table C1-3 in FEMA 356 (2000). According to FEMA P695. If less than one half of the records cause collapse, the structure meets the collapse performance objective and collapse probability of the structure under MCE (Maximum Considered Earthquake) ground motions is accepted. In this study normalized records are applied to 6, 12 and 20 stories frames that are designed by PBPD and ordinary method. Results show that frames that are designed by PBPD and ordinary method have acceptable collapse probability and structures meet target collapse limit. The number of earthquakes that cause collapse in the PBPD and ordinary structures are shown in Table 8.

SAC Name	Record	Duration (sec)	PGA (cm/sec <sup>2</sup> )
LA01	Imperial Valley, 1940, El Centro	39.38	452.03
LA03	Imperial Valley, 1979, Array #05	39.38	386.04
LA05	Imperial Valley, 1979, Array #06	39.08	295.69
LA07	Landers, 1992, Barstow	79.98	412.98
LA09	Landers, 1992, Yermo	79.98	509.7
LA11	Loma Prieta, 1989, Gilroy	39.98	652.49
LA13	Northridge, 1994, Newhall	59.98	664.93
LA15	Northridge, 1994, Rinaldi RS	14.945	523.3
LA17	Northridge, 1994, Sylmar	59.98	558.43
LA19	North Palm Springs, 1986	59.98	999.43
LA21	1995 Kobe	59.98	1258
LA23	1989 Loma Prieta	24.99	409.95
LA25	1994 Northridge	14.945	851.62
LA27	1994 Northridge	59.98	908.7
LA29	1974 Tabas	49.98	793.45
LA31	Elysian Park (simulated)	29.99	1271.2
LA33	Elysian Park (simulated)	29.99	767.26
LA35	Elysian Park (simulated)	29.99	973.16
LA37	Palos Verdes (simulated)	59.98	697.84
LA39	Palos Verdes (simulated)	59.98	490.58
LA41	Coyote Lake, 1979	39.38	578.34
LA43	Imperial Valley, 1979	39.08	140.67

**Table 6:** Character of selected ground motion.

Frame	a	b	R2	$\beta_M$	$\beta_{CL}$	$\beta_D/PGA$	$\lambda_{CL}CP$
PBPD	2.37	0.88	0.51	0.3	0.3	0.64	1.6
Ordinary	2.75	1.09	0.58	0.3	0.3	0.67	1.6

Table 7: Requirement parameter for obtaining fragility curve in 12 story frame.

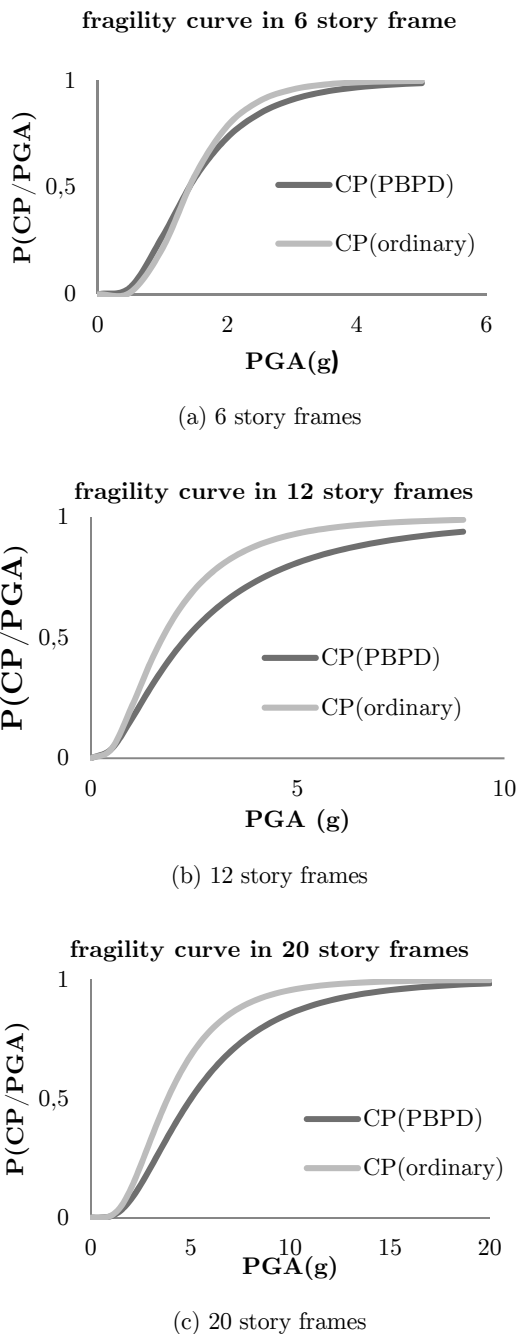

Figure 10: Fragility curve in frames that are designed by PBPD and ordinary method.

Number of story	PBPD method	ordinary method
6	11/22	6/22
12	11/22	7/22
20	9/22	5/22

**Table 8:** Number of Earthquake that cause collapse in structures.

## 8 CONCLUSION

After designing the structures by the PBPD and ordinary methods, and applying the nonlinear static and dynamic analysis to the structures, the following results are obtained:

- The number of hinges in the structures designed by PBPD method is more than the hinges in the structures designed by conventional method. It can be concluded that more energy is dissipated in structures that are designed by PBPD method. It is also seen that in the structures that are designed by conventional method unexpected mechanism may occur.
- The stiffness and strength of structures that are designed by PBPD method are less than structures that are designed by conventional method. In structures that are designed by conventional method the plastic deformation are concentrated in some members and strength drop may occur. But in structures that are designed by PBPD method the plastic deformation are more distributed over the structure.
- The ductility demand of structures that are designed by PBPD method is more than the structures that are designed by conventional method.
- The maximum story drift and link rotation of the Frames that are designed by PBPD method at the performance point are larger than the frames that are designed by ordinary method. However they are less than the acceptable limits. In Frames that are designed by PBPD method the plastic deformations are distributed over the height, but in frames that are designed by ordinary method they are concentrated at some stories and members which may lead to unexpected damages.
- The structures that are designed by PBPD method have less strength and more ductility demands than frames that are designed by ordinary method. It means that in PBPD method ductility of structures is better conducted to the design of structures.
- Results show the frames that are designed based on PBPD and ordinary methods have acceptable collapse probability and both structures meet target collapse limit.

## REFERENCE

- Bai J.W.,(2004) “ Seismic Fragility and retrofitting for a reinforced concrete flat-slab structure.” Master’s Thesis. Texas A&M university, Collage Station, TX.
- Banihashemi, M.R. Mirzagoltabar, A.R. Tavakoli. H.R. (2015). “Performance-based plastic design method for steel concentric braced frames”. *International Journal of Advanced Structural Engineering (IJASE)*. 7:281-293. DOI: 10.1007/s40091-015-0099-0.
- Banihashemi, M.R. Mirzagoltabar, A.R. Tavakoli. H.R. (2015).” Development of the performance based plastic design for steel moment resistant frame”. *International Journal of Steel Structures*. 15(1):51-62. DOI: 10.1007/s13296-015-3004-6.

- Bayat., and Chao, S.-H., Goel, S. C, and Liao, W.-C. (2010). "Performance-based plastic design (PBPD) method for earthquake-resistant structures: an overview". *The Structural Design of Tall and Special Buildings*. 19:115-137. DOI: 10.1002/tal.547.
- Chao SH and Goel SC. (2006a). "A seismic design method for steel concentric braced frames for enhanced performance". 4th international conference on earthquake engineering. Taipei. Taiwan.
- Chao SH and Goel SC. (2006b). "Performance based seismic design of special truss moment frames". 4th international conference on earthquake engineering. Taipei. Taiwan.
- Chao SH. Goel SC. (2006). "Performance-based design of eccentrically braced frames using target drift and yield mechanism". *AISC Engineering Journal* Third quarter: 173–200.
- Chao SH. Goel SC. (2008). "Performance-based plastic design of seismic resistant special truss moment frames". *AISC Engineering Journal*. Second quarter: 127–150.
- Chao SH. Goel SC. Lee S-S. (2007). "A seismic design lateral force distribution based on inelastic state of structures". *Earthquake Spectra*. 23( 3):547–569. DOI: <http://dx.doi.org/10.1193/1.2753549>.
- Chao SH. Goel SC. (2005). "Performance-Based Seismic Design of EBF Using Target Drift and Yield Mechanism as Performance Criteria". Report No. UMCEE 05-05. Department of Civil and Environmental Engineering, University of Michigan. Ann Arbor. MI.
- Dasgupta P. Goel SC. Parra-Montesinos G. Tsai, K.C (2004). "Performance-based seismic design and behavior of a composite buckling restrained braced frame (BRBF)". In *Proceedings of Thirteenth World Conference on Earthquake*.
- Er-Gang Xiong. Fei-Fei Cui. Liang Bai. Han He. (2016). "Performance-Based Plastic Design Method for Steel Concentrically Braced Frames Using Target Drift and Yield Mechanism". *Periodica Polytechnica Civil Engineering*. 60(1):127-134. DOI: 10.3311/PPci.7383.
- FEMA 356, (2000). "Pre-standard and Commentary for the seismic Rehabilitation of Buildings". Prepared by the American Society of Civil Engineers for the Federal Emergency Management Agency. Reston. VA.
- FEMA 440, (2005), "Improvement of nonlinear static seismic analysis procedure". Prepared by the Applied Technology Council for department of homeland security federal emergency management agency. Washington. D.C.
- FEMA P695, (2009), "Quantification of building seismic performance factors". Prepared by the Applied Technology Council for the Federal Emergency Management Agency. California.
- Goel SC. Chao SH. (2008). "Performance-Based Plastic Design: Earthquake Resistant Steel Structures". International Code Council. Washington. DC.
- Housner GW. (1956). "Limit design of structures to resist earthquakes". In *Proceedings of First World Conference on Earthquake Engineering*. Earthquake Engineering Research Institute. Berkeley.
- Karamodin A. Zanganeh A.(2016) "Seismic Performance of couple shear wall with steel link using PBPD method", *Sharif journal*.
- Khampanit.A. Leelataviwat. S. Kochanin. J. Warnitchai. P. (2014). "Energy-based seismic strengthening design of non-ductile reinforced concrete frames using buckling-restrained braces". *Engineering Structures*. 81:110-122. DOI: 10.1016/j.engstruct.2014.09.033
- Lee SS and Goel SC. (2001). "Performance-Based Design of Steel Moment Frames Using Target Drift and Yield Mechanism". Report No. UMCEE 01-17. Department of Civil and Environmental Engineering. University of Michigan. Ann Arbor. MI.
- Leelataviwat S. Goel S C and Stojadinović B. (1999). "Toward Performance-Based Seismic Design of Structures". *Earthquake Spectra*. 15 (3): 435-461. DOI: <http://dx.doi.org/10.1193/1.1586052>.
- Leelataviwat S. Goel SC and Stojadinović B. (1998). "Drift and Yield Mechanism Based Seismic Design and Upgrading of Steel Moment Frames". Report No. UMCEE 98-29. Department of Civil and Environmental Engineering. University of Michigan. Ann Arbor.

- Leelataviwat S. Saewon W. Goel S.C. (2007). "An energy based method for seismic evaluation of structures". In Proceedings of Structural Engineers Association of California Convention. SEAOC 2007. Lake Tahoe. CA.
- Liao. W. -C. Goel. S. C. and Chao. S. -H. (2010). "Performance Based Plastic Design (PBPD) of RC special moment frame structures". Concrete under Severe Conditions. 2: 1631 -1638. DOI: 10.1201/b10552-224.
- Liao. W.-C. and Goel S. C. (2012). "Performance-based plastic design and energy-based evaluation of seismic resistant RC moment frame". Journal of Marine Science and Technology. 20(3): 304-310.
- Roeder. C. W. and Popov. E. P. (1977). "Inelastic Behavior of Eccentrically Braced Steel Frames Under Cyclic Loadings". Report No. UCB/EERC-77/18. Earthquake Engineering Research Center. University of California at Berkeley.
- SAC steel ground motion, "Suites of Earthquake Ground Motions for Analysis of Steel Moment Frame Structures", [http://nisee.berkeley.edu/data/strong\\_motion/sacsteel/ground\\_motions.html](http://nisee.berkeley.edu/data/strong_motion/sacsteel/ground_motions.html).
- Sahoo. D.-R. and Chao. S. H. (2010). "Performance-based plastic design method for buckling-restrained braced frames". Engineering Structures. 32: 2950-2958. DOI: 10.1016/j.engstruct.2010.05.014.
- Shayanfar. M.A. Rezaeian. A.R. Zanganeh. A. (2014). "Seismic performance of eccentrically braced frame with vertical link using PBPD method". THE STRUCTURAL DESIGN OF TALL AND SPECIAL BUILDINGS. 23(1): 1-21. DOI: 10.1002/tal.1015.
- Swapnil B. Kharmale. Siddhartha Ghosh. (2013). "Performance-based plastic design of steel plate shear walls". Journal of Constructional Steel Research. 90: 85-97. DOI: 10.1016/j.jcsr.2013.07.029.
- Wen. Y. K., Ellingwood. B.R. and Bracci. J. (2004). "Vulnerability Function Framework for Consequence-based Engineering", MAE Center Project DS-4 Report, Mid-America Earthquake Center, University of Illinois at Urbana-Champaign.